

**COBALT® Exposed Manual
Flush Valve for Water Closets**

2.4 gpf / 9.0 Lpf

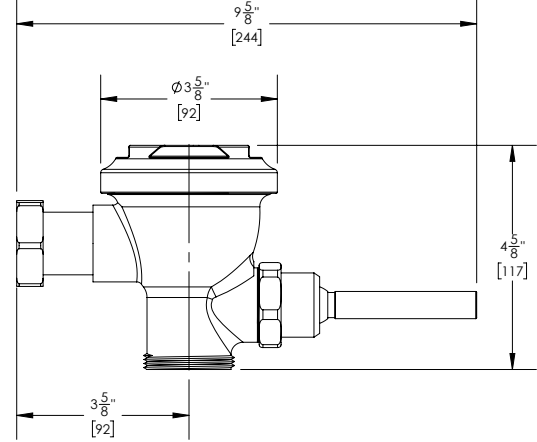

Part No. 101105 : 3000 : 2.4

► **Description**

COBALT® Exposed Manual Flush Valve for Water Closets;
2.4 gpf / 9.0 Lpf; Less Vacuum Breaker; Less Control Stop

► **Features**

- 2.4 gpf / 9.0 Lpf
- Patented ProLAST® T-Seal, featuring a single-piece design, glass-reinforced polymer substrate with TPE overmolded seals
- Integral, stainless steel bypass filter
- TPE overmolded seals are chlorine and chloramine resistant to prevent failure in the worst water conditions
- Dynamic sealing design provides accurate and consistent flush performance over time
- No external flush volume adjustment
- ADA compliant, non-hold open handle
- Adjustable tailpiece allows for variations in rough-in

► **Water Closet Flush Volume**

2.4 gpf / 9.0 Lpf

► **Accessories**

For additional accessories, see the Accessories Section of the I-CON catalog or contact our Customer Service Team for details.



Recommended Specification

I-CON COBALT® 101105 3000 Exposed Manual Flush Valve is a manually operated, dynamic sealing exposed flush valve for water closets. The cast brass valve body has a polished, chrome-plated finish. It utilizes the I-CON patented ProLAST® T-Seal, featuring a single-piece design, glass-reinforced polymer substrate with TPE overmolded seals, and a stainless steel, integral bypass filter. It is ADA compliant with a non-hold open handle. The flush volume is 2.4 gpf / 9.0 Lpf.

 **WARNING:** Cancer and Reproductive Harm - www.P65Warnings.ca.gov

This space is for Architect/Engineer approval

The information contained in this document is subject to change without notice.