

**COBALT® Secure Exposed
Sensor Flush Valve for Urinals**

0.25 gpf / 1.0 Lpf

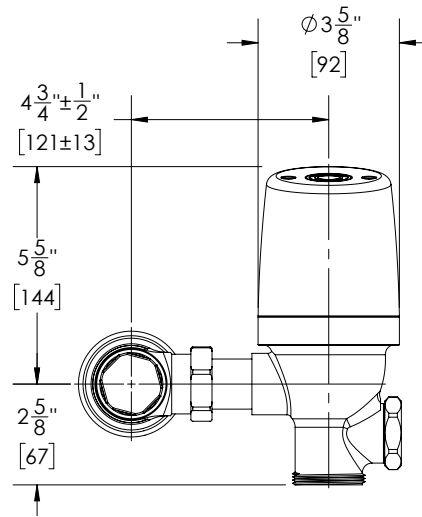

Part No. 101716 : 3005 : 0.25

► **Description**

COBALT® Secure Exposed Sensor Flush Valve for Urinals;
0.25 gpf / 1.0 Lpf; No Vacuum Breaker

► **Features**

- 0.25 gpf / 1.0 Lpf
- Patented ProLAST® T-Seal, featuring a single-piece design, glass-reinforced polymer substrate with TPE overmolded seals, and a stainless steel, integral bypass filter
- TPE overmolded seals are chlorine and chloramine resistant, to prevent failure in the worst water conditions
- Dynamic sealing design provides accurate and consistent flush performance over time
- All urinals use the same ProLAST® T-Seal for easy maintenance
- ADA compliant sensor activation
- No external flush volume adjustment
- Adjustable tailpiece allows for variations in rough-in
- Vandal-resistant TruTOUCH® sensor
- Runtime adjustable
- Screwdriver adjustable, back-flow preventing control stop with vandal resistant cap
- Sweat solder kit includes a threaded adapter, cover tub, and wall escutcheon
- 10+ years typical battery life at 17,500 uses per year*

► **Accessories**

For additional accessories, see the Accessories Section of the I-CON catalog or contact our Customer Service Team for details.



► **Urinal Flush Volume**

0.25 gpf / 1.0 Lpf

► **Actuator (must select one)**

- Standard TruTOUCH® Sensor
- LED TruTOUCH® Sensor

Recommended Specification

I-CON COBALT® Secure 101716 Exposed Sensor Flush Valve is an electronically operated, dynamic sealing, chrome-plated flush valve for urinals. It utilizes the I-CON patented ProLAST® T-Seal, featuring a single-piece design, glass-reinforced polymer substrate with TPE over-molded seals, and a stainless steel integral bypass filter. The valve is ADA-compliant. It includes a backflow-preventing control stop with a vandal-resistant stop cap and a sweat solder kit containing a threaded adapter, cover tube, and wall escutcheon. The flush volume is 0.25 gpf / 1.0 Lpf.

* battery life depends on usage, operating conditions, and storage conditions

IMPORTANT NOTE: Do not use abrasive or chemical cleaners and do not pressure wash valves.

 **WARNING:** Cancer and Reproductive Harm - www.P65Warnings.ca.gov

This space is for Architect/Engineer approval

The information contained in this document is subject to change without notice.