

## COBALT® Secure Exposed Sensor Flush Valve for Water Closets

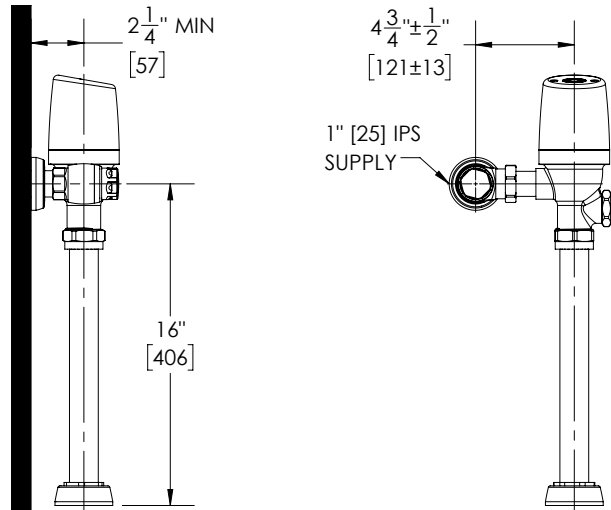

## Top Spud; 16" Rough-In 2.4 gpf / 9.0 Lpf



Part No. 101716 : 3015 : 2.4

### ► **Description**

COBALT® Secure Exposed Sensor Flush Valve for Water Closets;  
Top Spud; 16" Rough-In; 2.4 gpf / 9.0 Lpf

### ► **Features**

- 2.4 gpf / 9.0 Lpf
- Patented ProLAST® T-Seal, featuring a single-piece design, glass-reinforced polymer substrate with TPE overmolded seals, and a stainless steel, integral bypass filter
- TPE overmolded seals are chlorine and chloramine resistant, to prevent failure in the worst water conditions
- Dynamic sealing design provides accurate and consistent flush performance over time
- All water closets use the same ProLAST® T-Seal for easy maintenance
- ADA compliant sensor activation
- No external flush volume adjustment
- Adjustable tailpiece allows for variations in rough-in
- Vandal-resistant TruTOUCH® sensor
- Runtime adjustable
- Screwdriver adjustable, back-flow preventing control stop with vandal resistant cap
- Sweat solder kit includes a threaded adapter, cover tub, and wall escutcheon
- Flush connection kit includes a vacuum breaker, tubing, seals, escutcheons, and fittings for specified rough-in
- 10+ years typical battery life at 17,500 uses per year\*

### ► **Accessories**

For additional accessories, see the Accessories Section of the I-CON catalog or contact our Customer Service Team for details.



### ► **Water Closet Flush Volume**

2.4 gpf / 9.0 Lpf

### ► **Actuator (must select one)**

- Standard TruTOUCH® Sensor  LED TruTOUCH® Sensor

### ► **Control Stop**

- 1" I.P.S. Control Stop and Sweat Solder Kit

### Recommended Specification

**I-CON COBALT® Secure 101716 Exposed Sensor Flush Valve** is an electronically operated, dynamic sealing, chrome-plated flush valve for water closets. It utilizes the I-CON patented ProLAST® T-Seal, featuring a single-piece design, glass-reinforced polymer substrate with TPE over-molded seals, and a stainless steel integral bypass filter. The valve is ADA-compliant. It includes a backflow-preventing control stop with a vandal-resistant stop cap and a sweat solder kit containing a threaded adapter, cover tube, and wall escutcheon. The flush connection kit includes a vacuum breaker, tubing, seals, escutcheons, and fittings for a top spud, 16" rough-in. The flush volume is 2.4 gpf / 9.0 Lpf.

\* battery life depends on usage, operating conditions, and storage conditions

**IMPORTANT NOTE:** Do not use abrasive or chemical cleaners and do not pressure wash valves.

 **WARNING:** Cancer and Reproductive Harm - [www.P65Warnings.ca.gov](http://www.P65Warnings.ca.gov)

This space is for Architect/Engineer approval

The information contained in this document is subject to change without notice.