

## COBALT Pro® Exposed Sensor Flush Valve for Water Closets

**1.6 gpf / 6.0 Lpf**

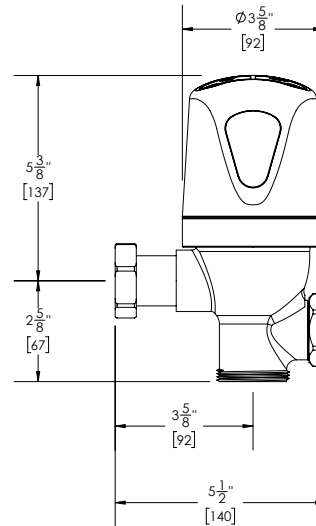

Part No. 101819 : 3000 : 1.6

### ► **Description**

COBALT Pro® Exposed Sensor Flush Valve for Water Closets;  
1.6 gpf / 6.0 Lpf; Less Vacuum Breaker; Less Control Stop

### ► **Features**

- 1.6 gpf / 6.0 Lpf
- Patented ProLAST® T-Seal, featuring a single-piece design, glass-reinforced polymer substrate with TPE overmolded seals, and a stainless steel, integral bypass filter
- TPE overmolded seals are chlorine and chloramine resistant to prevent failure in the worst water conditions
- Dynamic sealing design provides accurate and consistent flush performance over time
- TruFLUSH® volume control uses live water pressure data to maintain desired flush volumes
- All water closets use the same ProLAST® T-Seal for easy maintenance
- On-board usage tracking, battery monitoring, and obstruction monitoring with alerts
- Automatic sensor range adjustment
- ADA compliant sensor activation and override buttons
- No external flush volume adjustment
- Adjustable tailpiece allows for variations in rough-in

### ► **Accessories**

For additional accessories, see the Accessories Section of the I-CON catalog or contact our Customer Service Team for details.



### ► **Water Closet Flush Volume**

1.6 gpf / 6.0 Lpf

### **Recommended Specification**

**I-CON COBALT Pro® 101819 3000 Flush Valve** is sensor operated, dynamic sealing, and designed for water closets. The exposed, cast brass valve body has a polished, chrome-plated finish. It utilizes the I-CON patented ProLAST® T-Seal, featuring a single-piece design, glass-reinforced polymer substrate with TPE overmolded seals, and a stainless steel, integral bypass filter. The TruFLUSH® volume control uses live water pressure data to maintain desired flush volumes. The sensor activation and override buttons are ADA compliant. The flush volume is 1.6 gpf / 6.0 Lpf.

 **WARNING:** Cancer and Reproductive Harm - [www.P65Warnings.ca.gov](http://www.P65Warnings.ca.gov)

This space is for Architect/Engineer approval

The information contained in this document is subject to change without notice.