

COBALT Pro® Exposed Sensor Flush Valve for Water Closets

2.4 gpf / 9.0 Lpf

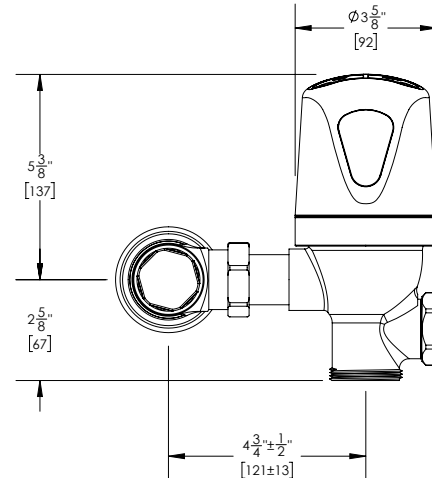

Part No. 101819 : 3005 : 2.4

► **Description**

COBALT Pro® Exposed Sensor Flush Valve for Water Closets;
2.4 gpf / 9.0 Lpf; Less Vacuum Breaker

► **Features**

- 2.4 gpf / 9.0 Lpf
- Patented ProLAST® T-Seal, featuring a single-piece design, glass-reinforced polymer substrate with TPE overmolded seals, and a stainless steel, integral bypass filter
- TPE overmolded seals are chlorine and chloramine resistant to prevent failure in the worst water conditions
- Dynamic sealing design provides accurate and consistent flush performance over time
- TruFLUSH® volume control uses live water pressure data to maintain desired flush volumes
- All water closets use the same ProLAST® T-Seal for easy maintenance
- On-board usage tracking, battery monitoring, and obstruction monitoring with alerts
- Automatic sensor range adjustment
- ADA compliant sensor activation and override buttons
- No external flush volume adjustment
- Adjustable tailpiece allows for variations in rough-in
- Screwdriver adjustable, backflow-preventing control stop with vandal-resistant cap
- Sweat solder kit includes a threaded adapter, cover tube, and wall escutcheon

► **Accessories**

For additional accessories, see the Accessories Section of the I-CON catalog or contact our Customer Service Team for details.



► **Water Closet Flush Volume**

2.4 gpf / 9.0 Lpf

► **Control Stop**

1" I.P.S. Control Stop and Sweat Solder Kit

Recommended Specification

I-CON COBALT Pro® 101819 3005 Flush Valve is a sensor operated, dynamic sealing exposed flush valve for water closets. The cast brass valve body has a polished, chrome-plated finish. It utilizes the I-CON patented ProLAST® T-Seal, featuring a single-piece design, glass-reinforced polymer substrate with TPE overmolded seals, and a stainless steel, integral bypass filter. The TruFLUSH® volume control uses live water pressure data to maintain desired flush volumes. The sensor activation and override buttons are ADA compliant. It includes a backflow-preventing control stop with a vandal-resistant stop cap and a sweat solder kit containing a threaded adapter, cover tube, and wall escutcheon. The flush volume is 2.4 gpf / 9.0 Lpf.

 **WARNING:** Cancer and Reproductive Harm - www.P65Warnings.ca.gov

This space is for Architect/Engineer approval

The information contained in this document is subject to change without notice.