

**COBALT Pro® Wall Sensor
Exposed Flush Valve for Urinals**

1.0 gpf / 3.8 Lpf

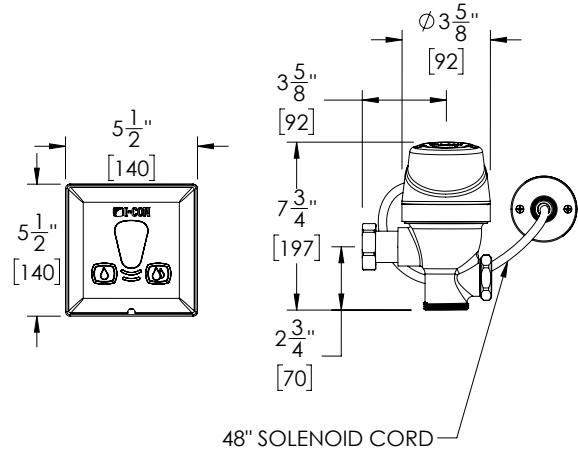

Part No. 101822 : 3000 : 1.0

► **Description**

COBALT® Pro Wall Sensor Exposed Flush Valve for Urinals; 1.0 gpf / 3.8 Lpf; Less Vacuum Breaker; Less Control Stop

► **Features**

- 1.0 gpf / 3.8 Lpf
- Patented ProLAST® T-Seal, featuring a single-piece design, glass-reinforced polymer substrate with TPE overmolded seals, and a stainless steel, integral bypass filter
- TPE overmolded seals are chlorine and chloramine resistant, to prevent failure in the worst water conditions
- Dynamic sealing design provides accurate and consistent flush performance over time
- TruFLUSH® volume control uses live water pressure data to maintain desired flush volumes
- All urinals use the same ProLAST® T-Seal for easy maintenance
- On-board usage tracking, battery monitoring, and obstruction monitoring with alerts
- Automatic sensor range adjustment
- ADA compliant sensor activation and override buttons
- No external flush volume adjustment
- Adjustable tailpiece allows for variations in rough-in.

► **Accessories**

For additional accessories, see the Accessories Section of the I-CON catalog or contact our Customer Service Team for details.

► **Urinal Flush Volume**

1.0 gpf / 3.8 Lpf

► **Transformer**

- Plug-in Transformer 100476
(sold separately, can power up to two wall sensor flush valves)

Recommended Specification

I-CON COBALT Pro® 101822 3000 Series Flush Valve is wall sensor operated and designed for urinals. It features dynamic sealing for accurate and extended flush performance. The exposed cast brass valve body has a polished, chrome-plated finish. It utilizes the I-CON patented ProLAST® T-Seal, featuring a single-piece design, glass-reinforced polymer substrate with TPE overmolded seals, and a stainless steel, integral bypass filter. The TruFLUSH® volume control uses live water pressure data to maintain desired flush volumes. It can be hardwired or use a plug-in transformer. ADA compliant sensor activation and override buttons. The flush volume is 1.0 gpf / 3.8 Lpf.

 **WARNING:** Cancer and Reproductive Harm - www.P65Warnings.ca.gov

This space is for Architect/Engineer approval



The information contained in this document is subject to change without notice.