

**COBALT Pro® Wall Sensor  
Exposed Flush Valve for Water Closets**

**1.1 gpf / 4.2 Lpf**

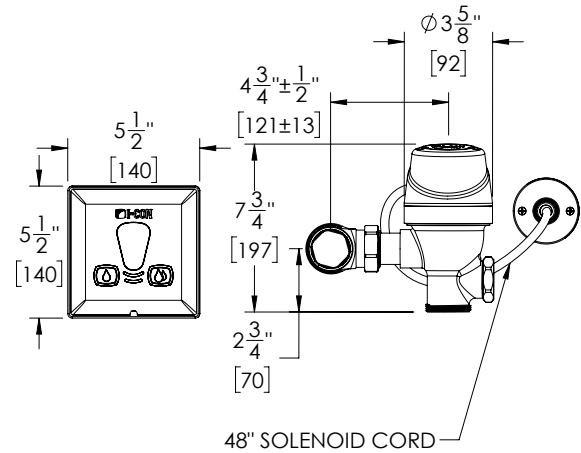

Part No. 101822 : 3005 : 1.1

► **Description**

COBALT® Pro Wall Sensor Exposed Flush Valve for Water Closets; 1.1 gpf / 4.2 Lpf; Less Vacuum Breaker

► **Features**

- 1.1 gpf / 4.2 Lpf
- Patented ProLAST® T-Seal, featuring a single-piece design, glass-reinforced polymer substrate with TPE overmolded seals, and a stainless steel, integral bypass filter
- TPE overmolded seals are chlorine and chloramine resistant, to prevent failure in the worst water conditions
- Dynamic sealing design provides accurate and consistent flush performance over time
- TruFLUSH® volume control uses live water pressure data to maintain desired flush volumes
- All water closets use the same ProLAST® T-Seal for easy maintenance
- On-board usage tracking, battery monitoring, and obstruction monitoring with alerts
- Automatic sensor range adjustment
- ADA compliant sensor activation and override buttons
- No external flush volume adjustment
- Adjustable tailpiece allows for variations in rough-in
- Screwdriver adjustable, back-flow preventing control stop with vandal-resistant cap
- Sweat solder kit includes a threaded adapter, cover tube, and wall escutcheon

► **Accessories**

For additional accessories, see the Accessories Section of the I-CON catalog or contact our Customer Service Team for details.



► **Water Closet Flush Volume**

1.1 gpf / 4.2 Lpf

► **Control Stop**

1" I.P.S. Control Stop and Sweat Solder Kit

► **Transformer**

Plug-in Transformer 100476  
(sold separately, can power up to two wall sensor flush valves)

**Recommended Specification**

**I-CON COBALT Pro® 101822 3005 Series Flush Valve** is wall sensor operated and designed for water closets. It features dynamic sealing for accurate and extended flush performance. The exposed cast brass valve body has a polished, chrome-plated finish. It utilizes the I-CON patented ProLAST® T-Seal, featuring a single-piece design, glass-reinforced polymer substrate with TPE overmolded seals, and a stainless steel, integral bypass filter. The TruFLUSH® volume control uses live water pressure data to maintain desired flush volumes. It can be hardwired or use a plug-in transformer. ADA compliant sensor activation and override buttons. It includes a backflow preventing control stop with a vandal-resistant stop cap and a sweat solder kit containing a threaded adapter, cover tube, and wall escutcheon. The flush volume is 1.1 gpf / 4.2 Lpf.

 **WARNING:** Cancer and Reproductive Harm - [www.P65Warnings.ca.gov](http://www.P65Warnings.ca.gov)

This space is for Architect/Engineer approval

The information contained in this document is subject to change without notice.