

COBALT Pro® Wall Sensor Exposed Flush Valve for Water Closets

1.6 gpf / 6.0 Lpf

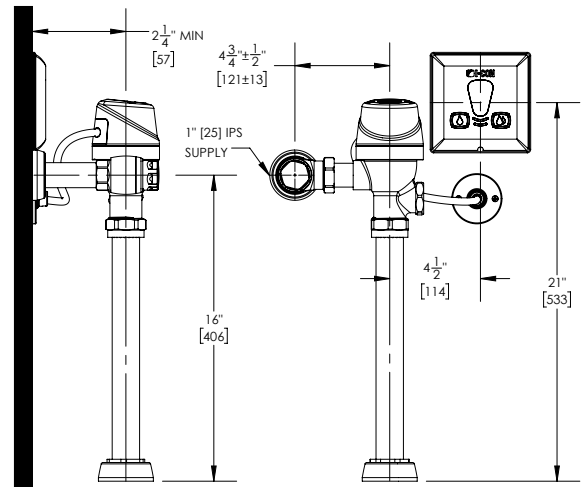

Part No. 101822 : 3015 : 1.6

► **Description**

COBALT® Pro Wall Sensor Exposed Flush Valve for Water Closets; Top Spud; 16" Rough-In; 1.6 gpf / 6.0 Lpf

► **Features**

- 1.6 gpf / 6.0 Lpf
- Patented ProLAST® T-Seal, featuring a single-piece design, glass-reinforced polymer substrate with TPE overmolded seals, and a stainless steel, integral bypass filter
- TPE overmolded seals are chlorine and chloramine resistant, to prevent failure in the worst water conditions
- Dynamic sealing design provides accurate and consistent flush performance over time
- TruFLUSH® volume control uses live water pressure data to maintain desired flush volumes
- All water closets use the same ProLAST® T-Seal for easy maintenance
- On-board usage tracking, battery monitoring, and obstruction monitoring with alerts
- Automatic sensor range adjustment
- ADA compliant sensor activation and override buttons
- No external flush volume adjustment
- Adjustable tailpiece allows for variations in rough-in
- Screwdriver adjustable, back-flow preventing control stop with vandal-resistant cap
- Sweat solder kit includes a threaded adapter, cover tube, and wall escutcheon
- Flush connection kit includes a vacuum breaker, tubing seals, escutcheons, and fittings for specified rough-in

► **Accessories**

For additional accessories, see the Accessories Section of the I-CON catalog or contact our Customer Service Team for details.

► **Water Closet Flush Volume**

1.6 gpf / 6.0 Lpf

► **Control Stop**

1" I.P.S. Control Stop and Sweat Solder Kit

► **Transformer**

Plug-in Transformer TRS-PI-120V-28V-1.5A
(sold separately, can power up to two wall sensor flush valves)

Recommended Specification

I-CON COBALT Pro® 101822 3015 Series Flush Valve is wall sensor operated and designed for water closets. It features dynamic sealing for accurate and extended flush performance. The exposed cast brass valve body has a polished, chrome-plated finish. It utilizes the I-CON patented ProLAST® T-Seal, featuring a single-piece design, glass-reinforced polymer substrate with TPE overmolded seals, and a stainless steel, integral bypass filter. The TruFLUSH® volume control uses live water pressure data to maintain desired flush volumes. It can be hardwired or use a plug-in transformer. ADA compliant sensor activation and override buttons. It includes a backflow preventing control stop with a vandal-resistant stop cap and a sweat solder kit containing a threaded adapter, cover tube, and wall escutcheon. The flush connection kit includes a vacuum breaker, tubing, seals, escutcheons, and fittings for a top spud, 16" rough-in. The flush volume is 1.6 gpf / 6.0 Lpf.

 **WARNING:** Cancer and Reproductive Harm - www.P65Warnings.ca.gov

This space is for Architect/Engineer approval

The information contained in this document is subject to change without notice.

