

## COBALT Pro® Wall Sensor Exposed Flush Valve for Water Closets

**2.4 gpf / 9.0 Lpf**

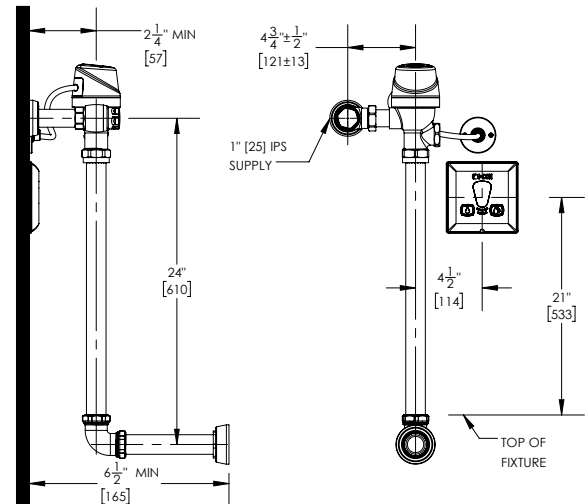

Part No. 101822 : 3040 : 2.4

### ► Description

COBALT® Pro Wall Sensor Exposed Flush Valve for Water Closets; Rear Spud; 24" Rough-In; 2.4 gpf / 9.0 Lpf

### ► Features

- 2.4 gpf / 9.0 Lpf
- Patented ProLAST® T-Seal, featuring a single-piece design, glass-reinforced polymer substrate with TPE overmolded seals, and a stainless steel, integral bypass filter
- TPE overmolded seals are chlorine and chloramine resistant, to prevent failure in the worst water conditions
- Dynamic sealing design provides accurate and consistent flush performance over time
- TruFLUSH® volume control uses live water pressure data to maintain desired flush volumes
- All water closets use the same ProLAST® T-Seal for easy maintenance
- On-board usage tracking, battery monitoring, and obstruction monitoring with alerts
- Automatic sensor range adjustment
- ADA compliant sensor activation and override buttons
- No external flush volume adjustment
- Adjustable tailpiece allows for variations in rough-in
- Screwdriver adjustable, back-flow preventing control stop with vandal-resistant cap
- Sweat solder kit includes a threaded adapter, cover tube, and wall escutcheon
- Flush connection kit includes a vacuum breaker, tubing seals, escutcheons, and fittings for specified rough-in

### ► Accessories

For additional accessories, see the Accessories Section of the I-CON catalog or contact our Customer Service Team for details.



### ► Water Closet Flush Volume

2.4 gpf / 9.0 Lpf

### ► Control Stop

- 1" I.P.S. Control Stop and Sweat Solder Kit

### ► Transformer

- Plug-in Transformer 100476  
(sold separately, can power up to two wall sensor flush valves)

### Recommended Specification

**I-CON COBALT Pro® 101822 3040 Flush Valve** is wall sensor operated and designed for water closets. It features dynamic sealing for accurate and extended flush performance. The exposed cast brass valve body has a polished, chrome-plated finish. It utilizes the I-CON patented ProLAST® T-Seal, featuring a single-piece design, glass-reinforced polymer substrate with TPE overmolded seals, and a stainless steel, integral bypass filter. The TruFLUSH® volume control uses live water pressure data to maintain desired flush volumes. It can be hardwired or use a plug-in transformer. ADA compliant sensor activation and override buttons. It includes a backflow preventing control stop with a vandal-resistant stop cap and a sweat solder kit containing a threaded adapter, cover tube, and wall escutcheon. The flush connection kit includes a vacuum breaker, tubing, seals, escutcheons, and fittings for a rear spud, 24" rough-in. The flush volume is 2.4 gpf / 9.0 Lpf.

 **WARNING:** Cancer and Reproductive Harm - [www.P65Warnings.ca.gov](http://www.P65Warnings.ca.gov)

This space is for Architect/Engineer approval

The information contained in this document is subject to change without notice.