

**COBALT® Concealed Manual
Flush Valve for Water Closets**

1.1 gpf / 4.2 Lpf

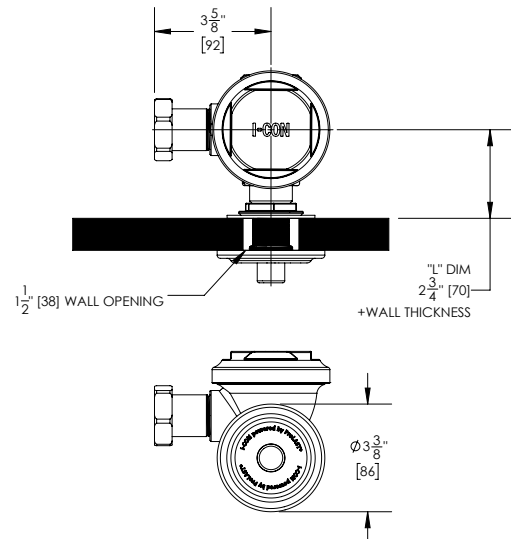

Part No. 101832 : 3200 : 1.1

► **Description**

COBALT® Concealed Manual Flush Valve for Water Closets;
1.1 gpf / 4.2 Lpf; Less Vacuum Breaker; Less Control Stop

► **Features**

- 1.1 gpf / 4.2 Lpf
- Patented ProLAST® T-Seal, featuring a single-piece design, glass-reinforced polymer substrate with TPE overmolded seals
- Integral, stainless steel bypass filter
- TPE overmolded seals are chlorine and chloramine resistant to prevent failure in the worst water conditions
- Dynamic sealing design provides accurate and consistent flush performance over time
- No external flush volume adjustment
- Non-hold open, vandal-resistant, push button actuator
- Adjustable tailpiece allows for variations in rough-in

► **Accessories**

For additional accessories, see the Accessories Section of the I-CON catalog or contact our Customer Service Team for details.



► **Water Closet Flush Volume**

1.1 gpf / 4.2 Lpf

► **“L” Dimension (must select one)**

- | | |
|---|--|
| <input type="checkbox"/> 3-3/4" (95mm) | <input type="checkbox"/> 9-3/4" (248mm) |
| <input type="checkbox"/> 4-3/4" (121mm) | <input type="checkbox"/> 10-3/4" (273mm) |
| <input type="checkbox"/> 5-3/4" (146mm) | <input type="checkbox"/> 11-3/4" (298mm) |
| <input type="checkbox"/> 6-3/4" (171mm) | <input type="checkbox"/> 12-3/4" (324mm) |
| <input type="checkbox"/> 7-3/4" (197mm) | <input type="checkbox"/> 13-3/4" (349mm) |
| <input type="checkbox"/> 8-3/4" (222mm) | <input type="checkbox"/> 14-3/4" (375mm) |

Recommended Specification

I-CON COBALT® 101832 3200 Concealed Manual Flush Valve is a manually operated, dynamic sealing exposed flush valve for water closets. The valve body is cast brass with a rough exterior finish. It utilizes the I-CON patented ProLAST® T-Seal, featuring a single-piece design, glass-reinforced polymer substrate with TPE overmolded seals, and a stainless steel, integral bypass filter. The push button actuator is non-hold open and vandal resistant. The flush volume is 1.1 gpf / 4.2 Lpf.

 **WARNING:** Cancer and Reproductive Harm - www.P65Warnings.ca.gov

This space is for Architect/Engineer approval

The information contained in this document is subject to change without notice.