

20" Combie Wall Sleeve Submittal & Installation 102637 SERIES

102637 (must select one)

► **Wall Thickness**

- 3-5/8" (102637 : 3-5/8")
- 5-5/8" (102637 : 5-5/8")
- 6" (102637 : 6")

- 7-5/8" (102637 : 7-5/8")
- 8" (102637 : 8")

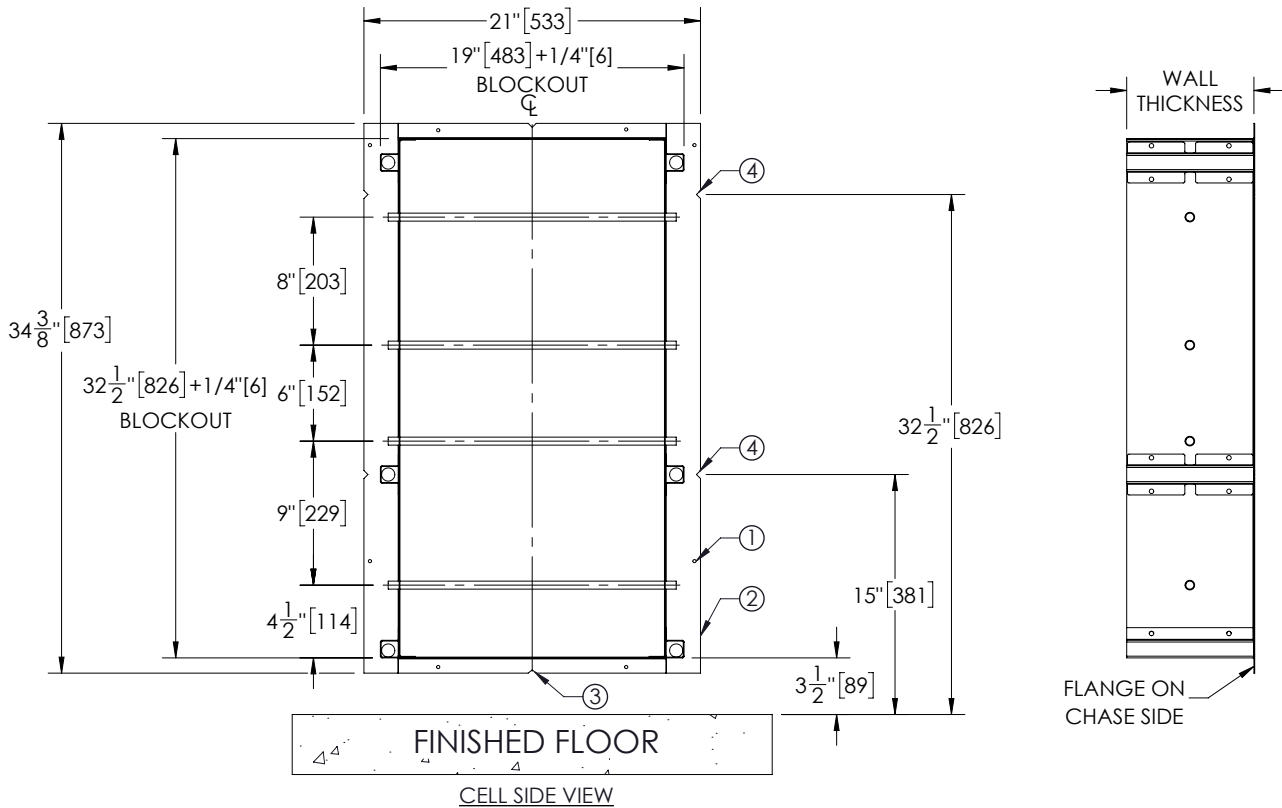

*Material is 18GA galvanized steel

WALL SLEEVES CAN BE INSTALLED USING NAIL HOLES PROVIDED (1) OR GROUDED INTO BLOCK, BECOMING A PERMANENT PART OF THE WALL.

NOTE: FOR POURED WALL CONSTRUCTION, TEMPORARY BRACING SHOULD BE INSTALLED WITHIN THE SLEEVE OPENING TO PREVENT DEFORMATION OF THE SLEEVE WHICH MAY OCCUR DURING POURING. DO NOT POUR CONCRETE DIRECTLY ON TOP OF THE WALL SLEEVE.

- A. INSTALL WALL SLEEVE WITH FLANGE (2) ON CHASE SIDE.
- B. LOCATE TOP AND BOTTOM NOTCHES (3) ALONG VERTICAL CENTERLINE OF WALL SLEEVE.
- C. SIDE NOTCHES (4) SHOULD BE LOCATED ABOVE THE FINISHED CELL SIDE FLOOR AT THE SPECIFIED HEIGHT.
- D. WHEN WALL SLEEVES ARE NOT AVAILABLE, USE THE BLOCKOUT DIMENSIONS.

Important! FIELD DIMENSIONS AND CONDITIONS VARY! Any field dimension must be submitted, in writing, on submittals when placing order. Accuracy is the full responsibility of the buyer. Any modification required to field conditions for proper install specified I-CON products are the responsibility of buyer/installer. Any field modification by others to the I-CON product voids manufacturer's warranty.

WARNING: Cancer and Reproductive Harm - www.P65Warnings.ca.gov
Important: Installation instructions and rough-in are included with each fixture. Do not modify these drawings. Do not rough in with certified dimensions. Dimensions are subject to manufacturer's tolerance of plus or minus 1/4" and change without notice. I-CON assumes no responsibility for use of voided or superseded data. © I-CON Systems

NOTE: Approved submittals and purchase order must be provided to I-CON Systems in writing before an order will be considered accepted. Material will be furnished per the design, dimensions, and tolerances in effect at the time the order is filled. Modifications to dimension, design, or material are not permitted after order is accepted.

Approved for Manufacturing

Company _____ Quantity _____
 Signature _____ Date _____