

20" Lavatory Fixture Wall Template

Submittal & Installation

102849

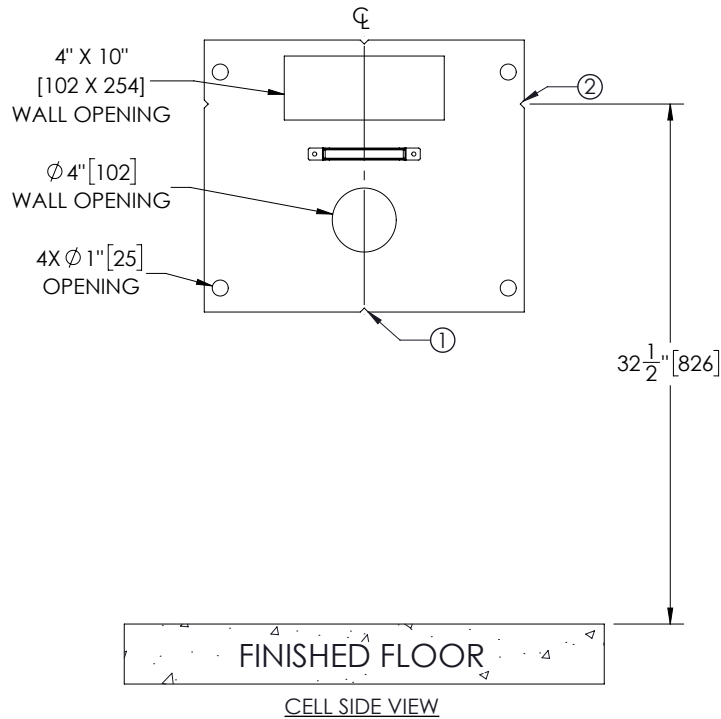

*Material is 18GA galvanized steel

TEMPLATES ARE USED TO OUTLINE THE REQUIRED WALL OPENINGS FOR SUBSEQUENT FLAME CUTTING OR CORE DRILLING.

- SCRIBE A HORIZONTAL CHALK LINE ON THE WALL AT THE "NOTCH" (2) DIMENSION SHOWN. MEASURE FROM THE FINISHED FLOOR ON CELL SIDE. THIS WILL LOCATE THE CENTERLINE FOR THE HORIZONTAL NOTCHES ON THE TEMPLATES.
- SCRIBE A VERTICAL CHALK LINE ON THE WALL AT THE "NOTCH" (1) TO INDICATE THE CENTERLINE OF THE FIXTURE. THIS WILL LOCATE CENTERLINE FOR THE VERTICAL NOTCHES ON TEMPLATE.
- PLACE THE TEMPLATE AGAINST THE WALL. LOCATE NOTCHES ALONG THE CHALK LINES. MARK THE WALL FOR REQUIRED OPENINGS.

Important! FIELD DIMENSIONS AND CONDITIONS VARY! Any field dimension must be submitted, in writing, on submittals when placing order. Accuracy is the full responsibility of the buyer. Any modification required to field conditions for proper install specified I-CON products are the responsibility of buyer/installer. Any field modification by others to the I-CON product voids manufacturer's warranty.

WARNING: Cancer and Reproductive Harm - www.P65Warnings.ca.gov
Important: Installation instructions and rough-in are included with each fixture. Do not modify these drawings. Do not rough in with certified dimensions. Dimensions are subject to manufacturer's tolerance of plus or minus 1/4" and change without notice. I-CON assumes no responsibility for use of voided or superseded data. © I-CON Systems

NOTE: Approved submittals and purchase order must be provided to I-CON Systems in writing before an order will be considered accepted. Material will be furnished per the design, dimensions, and tolerances in effect at the time the order is filled. Modifications to dimension, design, or material are not permitted after order is accepted.

Approved for Manufacturing
 Company _____ Quantity _____
 Signature _____ Date _____