

COBALT® Exposed Side Sensor Flush Valve for Water Closets

1.6 gpf / 6.0 Lpf

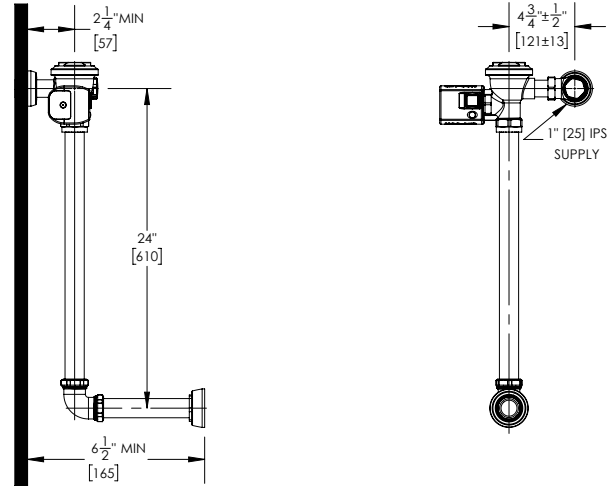
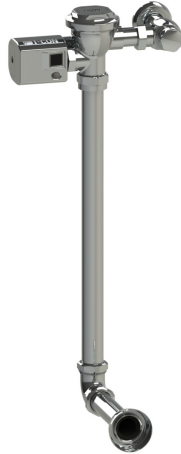

Part No. 103582 : 3040 : 1.6 : A

► **Description**

COBALT® Exposed Side Sensor Flush Valve for Water Closets;
Rear Spud; 24" Rough-In; 1.6 gpf / 6.0 Lpf

► **Features**

- 1.6 gpf / 6.0 Lpf
- Patented ProLAST® T-Seal, featuring a single-piece design, glass-reinforced polymer substrate with TPE overmolded seals, and a stainless steel, integral bypass filter
- TPE overmolded seals are chlorine and chloramine resistant to prevent failure in the worst water conditions
- Dynamic sealing design provides accurate and consistent flush performance over time
- Sensor angled at user for proper detection
- Yellow LED flashes when low battery
- No external flush volume adjustment
- ADA compliant sensor activation and override buttons
- Adjustable tailpiece allows for variations in rough-in
- Screwdriver adjustable, back-flow preventing control stop with vandal-resistant cap
- Sweat solder kit includes a threaded adapter, cover tube, and wall escutcheon
- Flush connection kit includes a vacuum breaker, tubing seals, escutcheons, and fittings for specified rough-in

► **Accessories**

For additional accessories, see the Accessories Section of the I-CON catalog or contact our Customer Service Team for details.



► **Water Closet Flush Volume**

1.6 gpf / 6.0 Lpf

► **Control Stop**

1" I.P.S. Control Stop and Sweat Solder Kit

Recommended Specification

I-CON COBALT® 103582 Standard 3040 Flush Valve has a metal-cased, side-mounted, sensor actuator and is designed for water closets. It features dynamic sealing for accurate and extended flush performance. The exposed, cast brass valve body has a polished, chrome-plated finish. It utilizes the I-CON patented ProLAST® T-Seal, featuring a single-piece design, glass-reinforced polymer substrate with TPE overmolded seals, and a stainless steel, integral bypass filter. ADA compliant sensor activation and override buttons. It includes a backflow preventing control stop with a vandal-resistant stop cap and a sweat solder kit containing a threaded adapter, cover tube, and wall escutcheon. The flush connection kit includes a vacuum breaker, tubing, seals, escutcheons, and fittings for a rear spud, 24" rough-in. The flush volume is 1.6 gpf / 6.0 Lpf.

 **WARNING:** Cancer and Reproductive Harm - www.P65Warnings.ca.gov

This space is for Architect/Engineer approval

The information contained in this document is subject to change without notice.