

KIT INCLUDES

- Sensor Cap Assembly
- ProLAST® T-Seal
- Actuator Opening Cover
- Wall Sensor
- Power & Interface Module

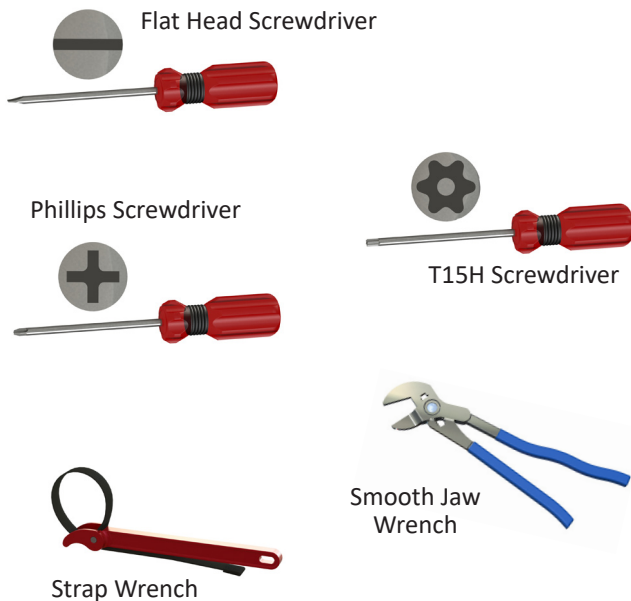

TOOLS NEEDED



PRIOR TO INSTALLATION

- All plumbing should be installed according to applicable state and local codes and regulations.
- Before installation of the I-CON flush valve, ensure the water closet or urinal fixture, drain line and water supply line are properly installed.
- Water supply lines must be sized to allow for appropriate water flow for each fixture.
- Flush all water supply lines of any debris before making connections.
- Do not use pipe sealant or plumbing grease on any components or couplings, with the exception of the control stop inlet.
- A smooth jaw or strap wrench should be used for installation to prevent damage to the finish of the I-CON flush valve and components.

The I-CON flush valve is designed to operate at water pressures ranging from 15 to 100psi (103 to 689kPa). The fixture type determines the minimum pressure required for the valve. Most low-consumption water closets are designed to operate with a minimum flowing water pressure of 25psi (172kPa). Many building codes and the ASME A112.19.2 standard state maximum static water pressure as 80 psi.

LIMITED WARRANTY

I-CON Systems (I-CON) warrants that its commercial manufactured products are made of first-class materials, are free from defects, and are made to withstand normal use when installed properly. Products have the following warranty periods: 3 years for COBALT®, COBALT Pro®, and COBALT Connect® faucets and flush valves and I-CON EDGE® gateways. 1 year for all other products and decorative finishes. The warranty period begins on the date of purchase.

Products should be sent to I-CON at the customer's expense. I-CON will take a reasonable amount of time to determine if the product is defective and whether it will be repaired or replaced. During the warranty period, items will either be (1) repaired at no charge using new replacement parts or (2) replaced with either a new similar product or one manufactured from new or serviceable used parts are, at minimum, a functional equivalent to the original. The course of action will be determined at I-CON's discretion. Replacement products that are installed according to the instructions provided by I-CON will assume the remaining warranty of the original product. The limited warranty is only applicable to the product's materials and workmanship. No claims for labor, transportation, or other incidental or consequential costs will be allowed. No extended warranties are available. THE SOLE AND EXCLUSIVE REMEDY FOR ANY DEFECTIVE PRODUCT IS LIMITED TO REPAIRING OR REPLACING THE DEFECTIVE PRODUCT. Before installing and using products, the purchaser is responsible for determining the products' suitability and assumes all risks and liabilities related to the product.

This warranty only applies to persons and organizations that purchase I-CON products directly from I-CON or an authorized I-CON representative for the purpose of resale. This warranty does not apply to the life of batteries or other consumables.

ELECTRICAL BOX INSTALLATION

Step 1

Install 2-gang electrical box (4" x 4" x 2-1/2"). The location will vary based on the rough-in. Refer to the rough-in drawings for specific mounting location. Use a GFCI plaster ring.

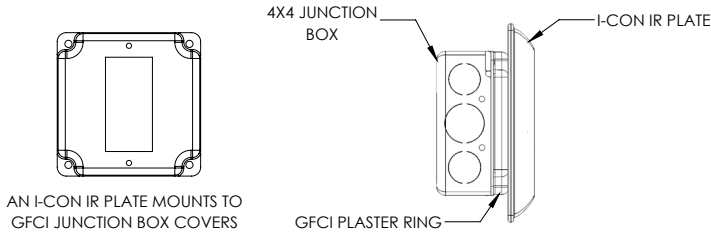

EXISTING COMPONENT REMOVAL

Step 1

Remove control stop cap.



Step 2

Turn adjustment screw **CLOCKWISE** to close control stop.



Step 3

Activate flush valve to relieve water pressure.



Step 4

Use strap wrench to remove flush valve cap. Remove actuator assembly and all inner components. Inner components commonly include a diaphragm, trip mechanism, and plastic internal cap.



Step 5

Install actuator cover.

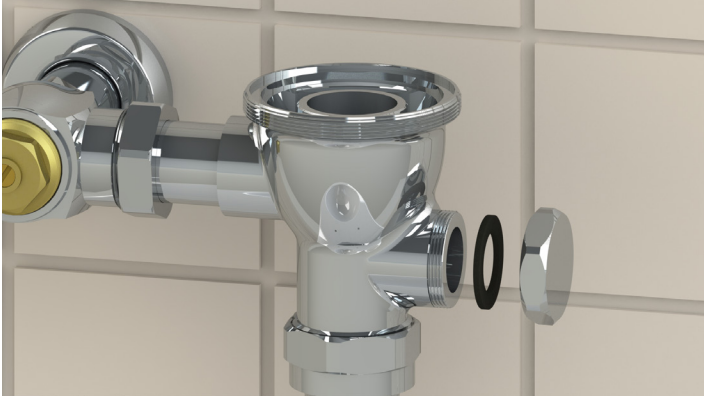

Step 3

Tighten locking ring by hand to flush valve body.



**ProLAST® T-SEAL & FLUSH VALVE CAP
ASSEMBLY INSTALLATION**

Step 1

Insert ProLAST® T-Seal into flush valve body.



Step 2

Place square-profile O-ring into groove on bottom of flush valve cap assembly. Place flush valve cap assembly onto flush valve body.

**WALL SENSOR INSTALLATION - INSTALLATION
WITH ELECTRICAL BOX**

Step 1

Loosen set screw on plate. Remove cover by pulling out then up.

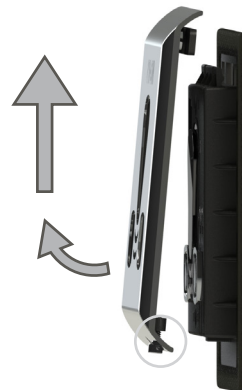

Step 2

Feed control module cable through junction box knock-out. Attach control module to junction box with provided screws.



Step 3

Reattach and secure cover with set screw.



Step 2

Drill openings for wall anchors using 3/16" drill. See dimensional drawing. Insert wall anchors.

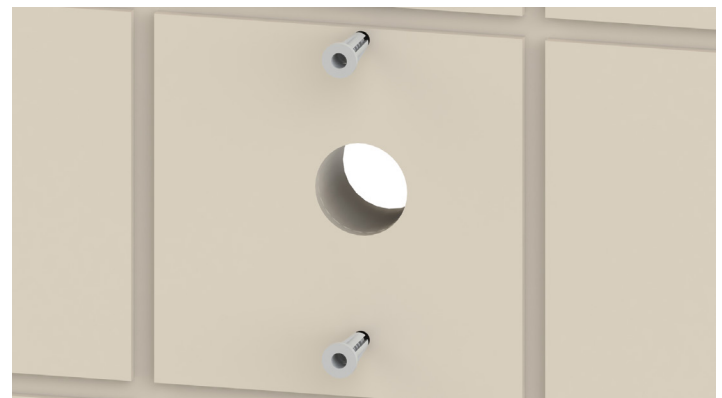
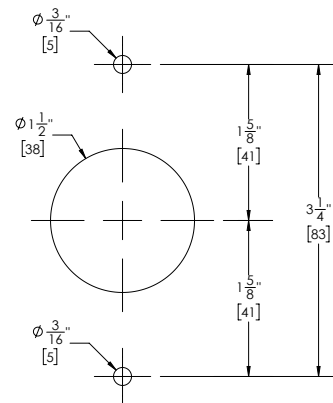

**WALL SENSOR INSTALLATION - INSTALLATION
WITHOUT ELECTRICAL BOX**

Step 1

Drill 1-1/2" hole through wall. The location will vary based on the existing flush valve installation. Typically installed 21" about the fixture on the centerline.

Step 3

Loosen set screw on face plate. Remove cover by pulling out then up.



Step 4

Feed control module cable through 1-1/2" opening. Attach control module to wall with provided screws.



Step 5

Reattach and secure face plate with set screw.



MOUNTING WALL FLANGE

Step 1

Drill the necessary holes to mount the wall flange. Refer to the dimensional drawing below. **NOTE:** The solenoid cable is 48" long and has 18" of conduit. Please allow for enough cable to go through the wall and plug into the interface box.

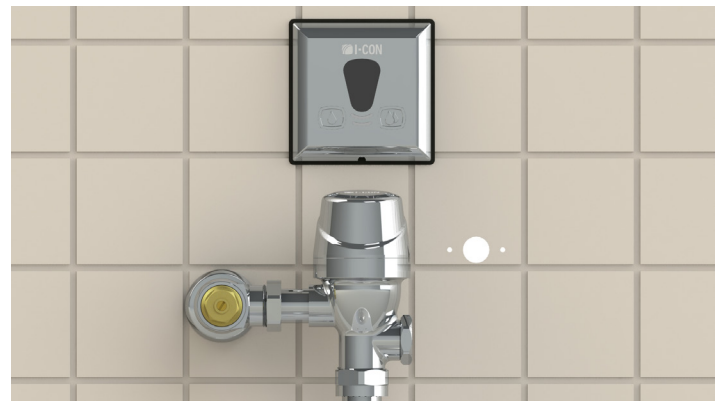
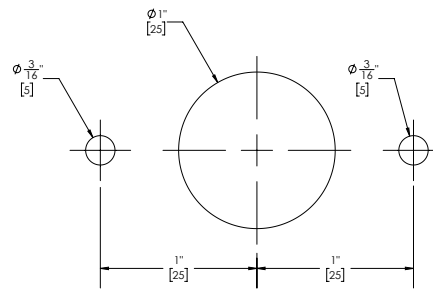

Step 2

Insert wall anchors into holes.

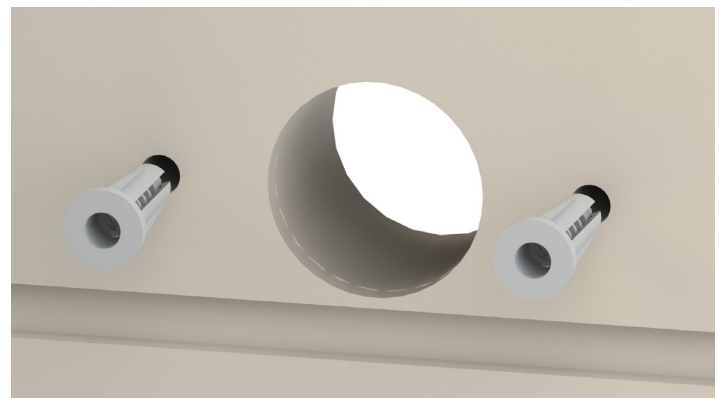

Step 3

Feed the solenoid cable conduit through the wall flange, then feed the cable through the wall.



Step 4

Attach the wall flange to the wall using the screws provided. Lock the conduit in place using the set screw on the wall flange.

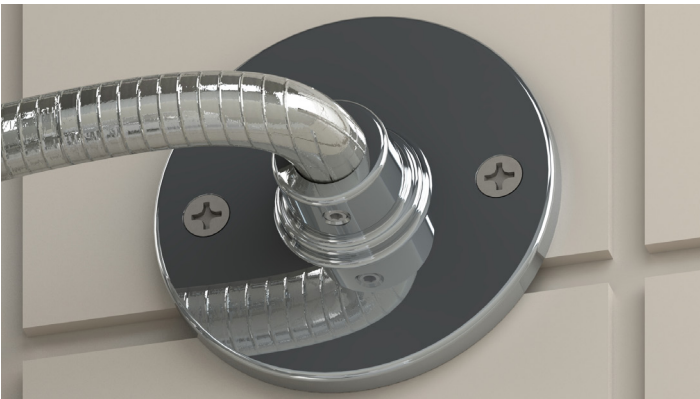

INTERFACE MODULE INSTALLATION

Step 1

Open interface module. Mount to flat surface in chase. Use wall anchors and screws provided. **NOTE:** The solenoid cable is 48" long and has 18" of conduit. Ensure the solenoid cable can be easily plugged into the interface box.

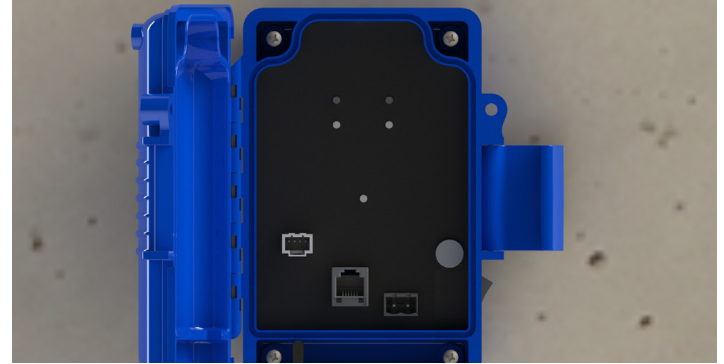

Step 2

Connect cables for pressure and temperature sensor, control module, solenoid, and power.

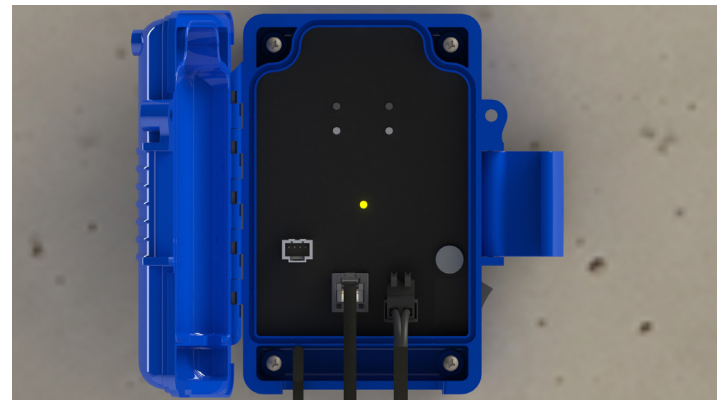

Step 3

Plug-in transformer. Power on interface module using external power switch. Close interface module.

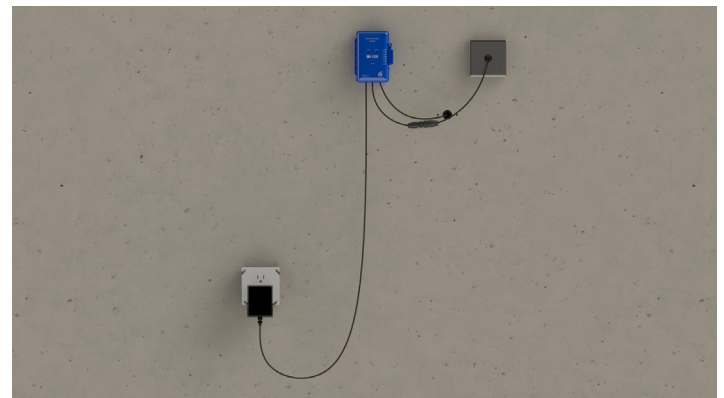

ADJUSTING CONTROL STOP

Step 1

Turn adjustment screw **COUNTERCLOCKWISE** 1/2 turn from closed position. Activate flush valve.



Step 2

To adjust flush valve, turn adjustment screw in small increments. Activate flush valve after each adjustment. The proper flow rate should completely cleanse fixture without splashing water outside of fixture.

NOTE: The flow from the valve must never exceed the flow capacity of the fixture. If a valve failure should occur, the fixture must be able to accommodate a continuous flow from the valve.



Step 3

Reinstall control stop cap.



CONTROL MODULE AND INTERFACE SETUP

NOTE: When powered and face plate is removed, control module automatically enters maintenance mode. While maintenance mode is active, a solid green light indicates that a user is detected. Control module exits maintenance mode when face plate is replaced or after 30 minutes. To re-enter maintenance mode, press any quick action button.

QUICK ACTION BUTTON DIAGRAM



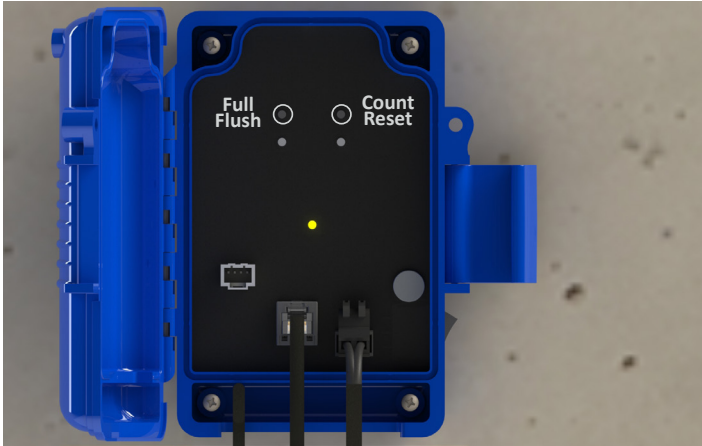

ACTIVATE

Activates a full flush of the flush valve.

ACTIVATION COUNT RESET

The activation count can be monitored by using the onboard display. It will display AC (Activation Count) followed by the number of activations since the last rebuild. A red LED blinking alarm will begin once the activation count has surpassed 250,000 cycles. At this time, it is recommended to rebuild the valve. To reset this alarm, press and hold the activation count reset for 5 seconds. The red LED will flash indicating the count has been reset to 0.

INSTALLATION COMPLETE

AUTO-RANGE

To set range automatically, press and hold the auto range quick action button for 3 seconds. Place target at desired detection range within 5 seconds. Green light blinks every second during countdown. Sensor will lock on to target, indicated by solid green light. Green light will blink to confirm range is set.

NOTE: Test range with targets of various colors and textures for accuracy. Ensure foreign objects, such as stall doors and mirrors, are not detected.

PROFILE

To view current profile, press and release profile quick action button. Current profile number is displayed through LED illuminations and the digital display. To change profile, press and release profile quick action button again. Continue to press and release profile quick action button until desired profile is displayed. Press and hold profile quick action button for 3 seconds to set profile. Blue lights will flash to indicate profile was saved.

Display	Profile	Flush Volume
P1 - Red & Blue	Profile 1	10% Water Savings
P2 - Blue	Profile 2	5% Water Savings
P3 - Green & Blue	Profile 3	Standard Flush Volume

PROGRAMMING QUICK REFERENCE



When adjustment LEDs are illuminated, their corresponding values appear on the display. Make adjustments as necessary. See standard operations guide for more information.

Range adjusts the maximum range used to detect a user. The range can be adjusted from 6-54 inches.

Exit adjusts the amount of time an object must not be detected before the valve considers the user to have exited. The range can be adjusted from 0-15 seconds.

Run adjusts the water volume savings in percent.

Redetect adjusts the amount of time a user must be out of range before another user can be detected. The range can be adjusted from 0-60 seconds.

CARE OF CHROME PLATED SURFACES

DO NOT use commercial cleaning compounds to clean flush valve. Abrasive or chemical cleaners may dull luster and attack finishes. Use mild soap and water and then dry with a clean nonabrasive cloth or towel. A microfiber cloth is recommended. Protect flush valve from any splattering when cleaning the floor, tile, or fixtures. DO NOT USE ACID OR ALCOHOL BASED CLEANERS.